



F&F Filipowski sp. j.
ul. Konstytucyjowa 79/81
95-200 Pabianice
tel/fax: 48 42 2270971 POLAND
e-mail: fif@fif.com.pl

CRT-04 DIGITAL TEMPERATURE REGULATOR



5 19 0 8 3 1 2 1 5 9 2 6 5 5

www.fif.com.pl

F&F products are covered by an 24 months warranty from date of purchase

PURPOSE

The CRT-04 controller is multi-function, programmable electronic devices which enable control of heating or cooling devices in order to maintain a stable room temperature, as well as to control ambient and substance temperatures in industrial conditions, with the option of supervising technological processes. The operation time and required temperature are achieved according to the individual program set by the user. The controller is equipped with a calendar and a real time clock which enable switching the controlled device on and off at preset hours within the following cycles: 24-hour, weekly, business-day (Mon. Fri.) or weekend (Sat., Sun.).

- DELAY programmable time of response delay while exceeding limit temperature values;
- CORRECTION related to the temperature read-out error against the model thermometer;
- SENSORS visual signalisation of the temperature sensor failure;
- DST automatic DST time implementation with programmable shift to manual mode;
- LIGHT selection of display illumination mode.
- LANGUAGE program menu in three languages: Polish, English or Russian

DESCRIPTION OF CONTROL PANEL:

To work and programming of regulator CRT-04 is use control panel. It include two line with eight sign on alfanumerical display and keyboard with five buttons, which is situated under the display.

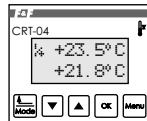

In automatic or constant work mode at upper line is displayed value of temperature which is set by user, but at lower line is presented value of actual temperature which is measure by sensor which is connect to regulator.

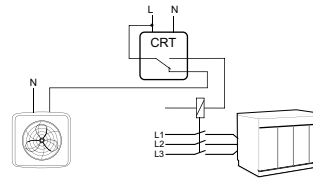
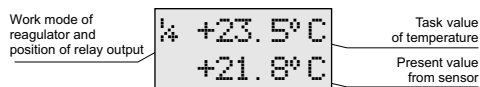

CRT - 04 is equipped to:

- controlling panel use for programming and monitor to work of regulator
- timer of real time with automatic function of change time summer - winter
- possibility of connection temperature probe RT4
- output of relay 1P with current load 16A

CONTROLLERS FEATURES:

- control panel for programming and monitoring;
- operation modes: HEATING and COOLING to maintain a preset temperature according to programmed hours and days;
- CONTINUOUS operating mode to maintain a single preset temperature value while ignoring other program entries;
- MEASUREMENT operating mode display of an actual temperature value without controlling a connected machine;
- 50 program entries;
- INTERVAL this feature enables the user to program up to 8 required temperature values (3 in the MY1, MY2 and MY3 modes, and an additional 5 in modes called MORNING, WORK, DINNER, DAY, and NIGHT for everyday time windows related to the users' lifestyle;

In measurement mode is displayed only lower line which present actual temperature read from sensor.

Signs on the left side of display, signalize work mode of regulator in position of output relay. This sign present:

	Work in automatic mode WARMING - open contact
	Work in automatic mode WARMING - close contact
	Work in automatic mode COOLING - open contact
	Work in automatic mode COOLING - close contact
	Work in mode CONTINUOUS - open contact
	Work in mode CONTINUOUS - close contact
	Value of task temperature was increase at handwork to respect value from program.
	Value of task temperature was reduce at handwork to respect value from program.

BUTTONS FUNCTIONS:

	In programming mode button MODE make to return main menu. If button will be push at edition mode, then program return to main menu without save all registry. At standard work of regulator button MODE enable to quick change of work mode. Button MODE enable to delete information about errors.
--	---

▲	At programming mode buttons UP and DOWN make to possibility to select position of menu and to increase or reduce value of edited parameter.
▼	At standar work this buttons enable to quick change value of task temperature .
OK	In programming system mode button OK enable to pass to selected position from menu and enter the changes. In standard work push button OK cause present actual date and time.
Menu	Button Menu enable to pass to programming mode of regulator.

FUNCTIONING:

In standard work mode regulator enable to make cyclic programs which were set by user at memory. Possible is make to 50 programming registry which needed define:

- day or days when will be make program. Possible is choose sibgle days(from monady to fsunday), work days, weekand and another.d
- time of start program
- one of eight definite by user value of task temperature (INTERVAL)

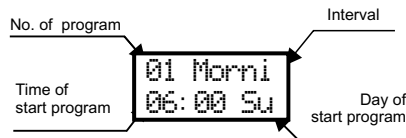

ATTENTION! Number of program are given automatically by regulator when the is set new program.

Structure of main menu:

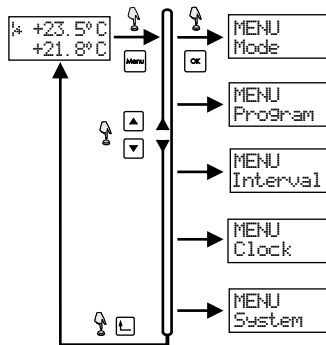

To select position from menu we use buttons "UP" and "DOWN". If you want pass to selected position then you need push button OK. Pass to main menu is possible by push button MENU.

Menu -> MODE

Regulator in WARMING mode:

Regulator make measurement result temperature between actual temperature from sensor C1 and task temperature Tprog. Which is set to executing program and for set width of hysteresis area H.

Programs are make in chronology, it mean they start with set time and date. Stop of program is make at the moment when the next program is start.

EXAMPLE:

The First program with temperature „morning” is execute at work days (RO) and is start at 6.00 am. The Second program with temperature „night” will be execute every day since 9 pm. The third program will be execute only weekand since 9 am. The last program with temperature “work” will be execute every Monday since 3 pm.

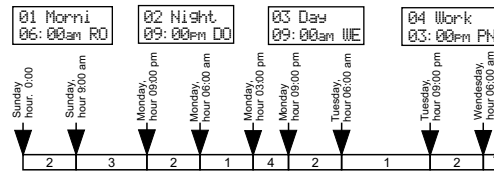

Execute program

ATTENTION! Programs which were save at higher position are processing earlier than programs from lower position. It mean, if we have two programs with the same action and time, than will be execute program with higher number.

PROGRAMMING

Pass to programming mode is possible by push button MENU.

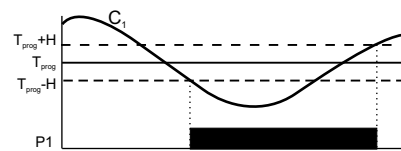

If temperature on input of sensor C1 fall to lower than value (Tprog - H), it cause close of joint P1. Open a joint P1 will make after the temperature on input C1 will be higher than temperature (Tprog + H).

Regulator in COOLING mode:

Regulator make measurement result temperature between actual temperature from sensor C1 and task temperature Tprog. Which is set to executing program and for set width of hysteresis area H.

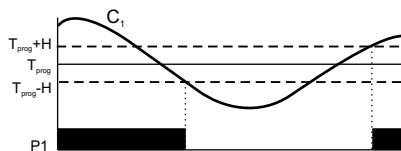

If temperature on input of sensor C1 increase to higher than value (Tprog+ H), it cause close of joint P1. Open a joint P1 will make after the temperature on input C1 will be lower than temperature (Tprog - H).

Regulator in CONTINUOUS mode:

Regulator make measurement result temperature between actual temperature from sensor C1 and constant temperature Tconst, which is set by user at the moment when is select work mode and for set width of hysteresis area H.

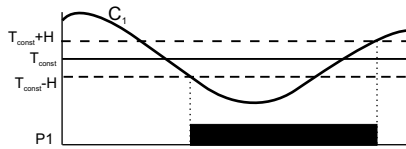

If temperature on input of sensor C1 fall to lower than value (Tconst - H), it cause close of relay joint P1. Open of relay joint P1 will make after the temperature on input C1 will be higher than temperature (Tconst + H).

Regulator in MEASUREMENT mode:

In this mode device is use only to display value of temperature. Joint P1 stay in open position.

Choose work mode:

1. By button MENU pass to main menu of regulator.
2. Push a button OK to enter pass to menu
3. By buttons "UP" and "DOWN" choose work mode and enter by button OK.

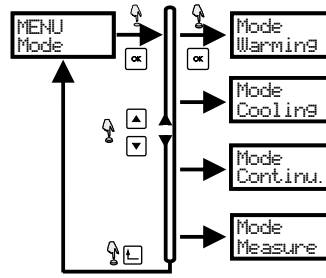

4. When you choose Continuous mode you should set temperature which will be hold by regulator.

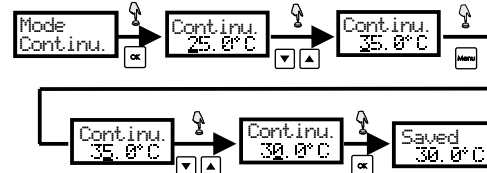

The first of all you set a digit of decimal position (digit which is edit is signalize by blinking underline sign), afterwards you pass to set next position by push a button MENU. After set all digits of task temperature enter by button OK.

Menu -> Program

Orders from menu Program make possibility to create, edit and delete programs which define behaviour of regulator in automatic work.

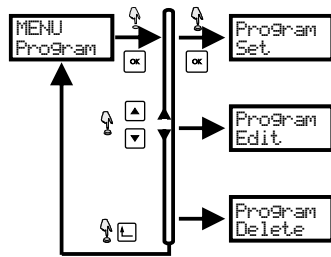

CREATE A NEW PROGRAM:

Stage of create a new program are following:

1. After pass to Menu -> Program and select program -> set and enter by button OK, by buttons "UP" and "DOWN" set a minute, enter by OK and set hour for start program (value which is edit is signalize by blinking underline minute and hour)
2. Push button OK and by buttons "UP" and "DOWN" set a day when will be start program. We have following option:

Monday, Tuesday, Wednesday, Thursday, Friday, Saturday, Sunday	Program will be start in choosen day
RO - Work days	Program will be start in every work day (from Monday to Friday).
WEekendy	Program will be start at Saturday and Sunday
DO - free day	Program will be start at every day of week.

Enter selected day by button OK.

3. By buttons "UP" and "DOWN" set a task temperature for present program.

ATTENTION!! Possible is choose one of eight values of temperature which were definite in MENU -> interval. Everyone of values are signed by parameters: Morning, Work, Dinner, Day, Night, Mine 1, Mine 2, mine 3. Changes value of temperature for present program is automaticly set for every programs with this parameter.

4. Save program in memory by button OK.

At any time possible is out from create new program mode, without save all registry, by button MENU.

Example of create a new program:

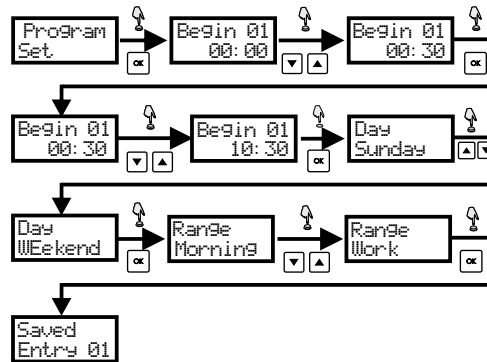

EDITION OF EXIST PROGRAM:

1. After pass to menu Program need to choose option Program -> edit and enter by button OK.
2. By buttons "UP" and "DOWN" select program which will be edit and enter by button OK.
3. Next operation are similarly as create new program.

Edition of program without save all change, could break by push button MODE.

DELETE PROGRAM

1. After pass to menu Program need to choose option Program -> delete and enter by button OK.
2. By buttons "UP" and "DOWN" select program which will be delete and enter by button OK.
3. Confirm delete of program by button OK.

ATTENTION! Delete program cause automatically change numbers of rest programs.

Menu -> Interval

Ordered value of temperature in programs which are make by regulator CRT-04 is not define in program code, but by group of eight parameters which comes from menu interval.

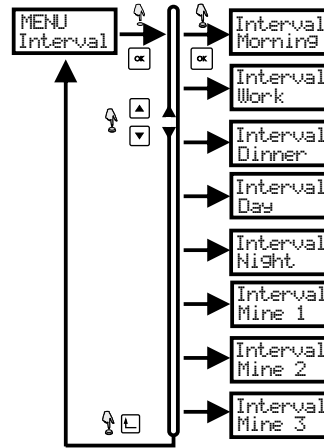

If you want change value of temperature which is connect with selected parameter need to:

1. After pass to menu Interval by buttons "UP" or "DOWN" select edited parameter.
2. Enter by button OK.
3. By buttons "UP" or "DOWN" set correct value for decimal position of degree.

4. If you wont pass to edit temperature on next position, push button Menu (edit position will be signalize by blinking underline sign)
5. Repeat procedure from point 3 and 4 need set all numbers with new value of ordered temperature.
6. Enter all changes by button OK.

Push a button any time in edit mode cause out from edition mode without save all changes.

Example of set a new value of temperature:

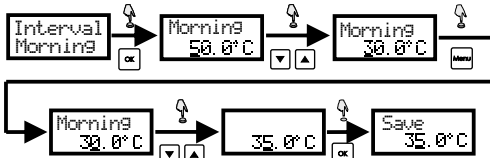

Menu -> Clock

This mode is use only for change date and time.

Set a DATE:

1. After pass to menu timer by buttons "UP" or "DOWN" select timer -> DATE and push button OK.
2. By buttons "UP" or "DOWN" set correct month, enter OK
3. By buttons "UP" or "DOWN" set correct day.

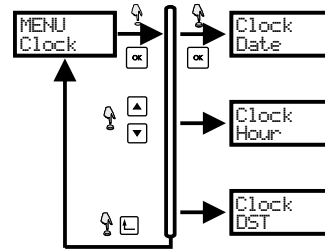

Example of procedure:

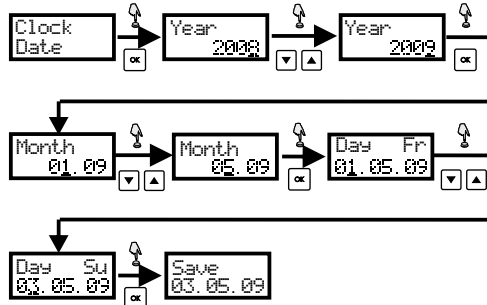

SET TIME:

1. After pass to menu timer by buttons "UP" or "DOWN" select menu **TIMER** and push button OK.
2. By buttons "UP" or "DOWN" select timer -> Hour and push button OK.
3. By buttons "UP" or "DOWN" set correct minute, enter OK
4. By buttons "UP" or "DOWN" set correct hour.
5. Push button OK.. cause enter changes and start count time from set value.

Example of procedure:

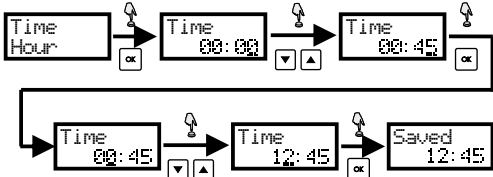

AUTOMATIC CHANGE TIME FUNCTION:

Regulator CRT-04 could automaticly change time from winter to summer and from summer to winter. This function will be make automatic or handwork, it is set by user.

If you want set function DST need to:

1. After pass to menu timer by buttons "UP" or "DOWN" select function **DST**.
2. Enter by button OK.
3. By buttons "UP" or "DOWN" choose option **Atomatic** (if regulator have automatic change time function) or **manual** (when change of time will not make).
4. Enter by button OK..

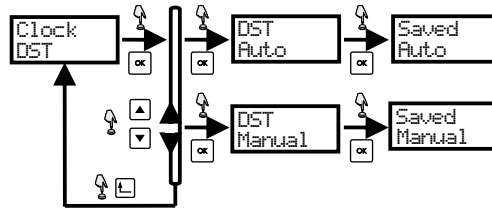

Menu -> System

This mode make possible to define additional functions of regulator CRT-04.

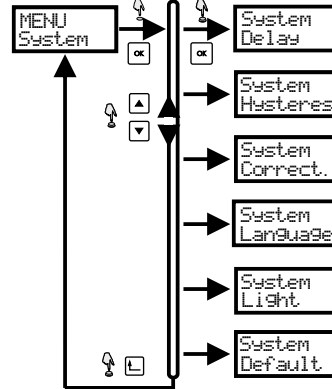

DELAY

This parameter make possibility to put delay of reconnection realy output by ordered time. In practic this function will be use at the situation when we wait for turn ON/OFF of heater, it will make when temperature go out from allow regulation area.

Example with use time delay by value T_{zw} and regulator is presented at under picture. In this cause condition of enclose is fall a temperature under value $(T_{prog} - H)$ for time T_{zw} , but condition of exclude is increase temperature higher than value $(T_{prog} + H)$ for time T_{zw} .

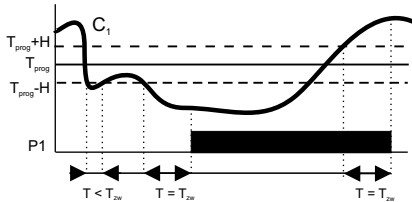

- If you need set a delay time of reconnection follow procedure:
1. Pass to menu -> System and by buttons "UP" or "DOWN" select option **System** -> **Delay**.
 2. Enter by button OK.
 3. By buttons "UP" and "DOWN" set value of delay.
 4. Enter by button OK.

Push a button any time in edit parameter cause out from edition mode without save all changes.

ATTENTION!: Delay time could be set in range $0 \div 15$ min., with step 1 min.

Example of setting delay

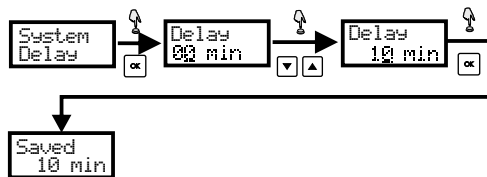

HYSTERESIS

This parameter make possibility to define precision and cleanliness with in will be reconnect output of relay at regulation of temperature. If value of hysteresis is smoler than precision is higher but enclose of heater component will be oftenly. But if the value of hysteresis is large that cause lower frequency of connection heater component and precision of regulation is lower.

Examples characteristics with two different hysteresis areas:

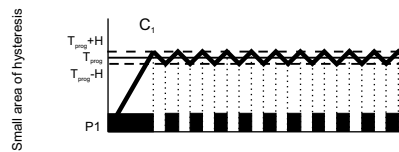

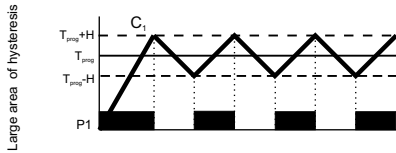

If you need set value of hysteresis follow with procedure:
 1. Pass to Menu -> System and by buttons "UP" or "DOWN" select option -> Hyst.
 2. Enter by button OK.
 3. By buttons "UP" or "DOWN" set value of hysteresis.
 4. Enter by push button OK.

At any time possible is out from edit parameter mode, without save all registry, by push button MENU.
ATTENTION! Hysteresis could be set in range 0+10°C, with step 0,1°C.

Example of setting hysteresis:



CORRECTION

This parameter is use for correction indication from sensor. To set correction indication of sensor follow the procedure:

1. Pass to Menu -> System and by buttons "UP" or "DOWN" select option System-> Correction
2. Enter by button OK.
3. By buttons "UP" or "DOWN" set value of correction.
4. Enter by button OK.

At any time possible is out from edit parameter mode, without save all registry, by push button MODE.

ATTENTION! Correction of sensor indication could set in range 5.0 ÷ -5.0 °C, with step 0,1°C.

Example of setting temperature correction:

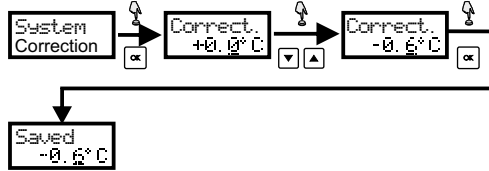

SELECT REPORT LANGUAGE

This parameter make possibility to choose on of three language in which will be display reports. If you need change language you need pass to menu System -> Language by buttons "UP" or "DOWN" select language and enter by button OK. Return to main menu is possible by push button MODE.

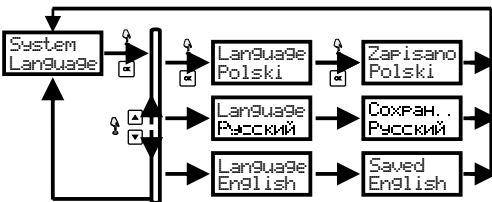

LIGHTING OF DISPLAY

This parameter make possibility to lighting a display of regulator. Possible is set lighting for all the time for display or lighting only for some second after push any button

If you need way of lighting you need to pass menu System -> Light and select by buttons "UP" or "DOWN" correct option and enter by button OK. Return to main menu is possible by push button MODE.

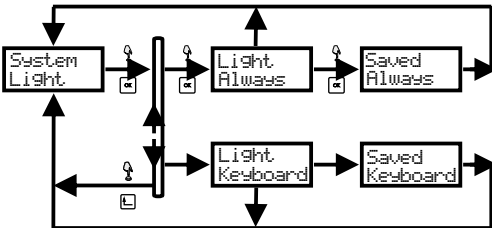

RETURN TO DEFAULT SETTINGS

Default settings make possibility to return all settings of regulator to target values. If you need restore default settings pass to menu System -> default settings and enter by button OK. Next by buttons "UP" or "DOWN" set value YES and push button OK.

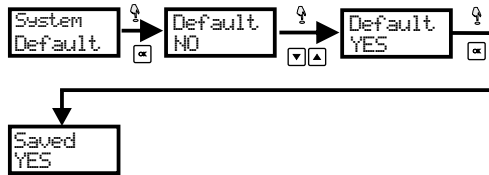

ATTENTION! Return to default settings cause delete all earlier configurations with saved programs.

Rest of parameters of regulators are set with values:

Mode	Handwork
Tzad (handwork)	25,0°C
Hysteresis	0,0°C
Delay	0min
Sensor correction	0,0°C
Correction of odered value	0,0°C
Interval	20,0°C (everyone)
Lighting of display	All time
DST	Automatic
Date / Time	01.01.2008 00:00

QUICK CONFIGURATION

Regulator CRT-04 make possibility choose work mode and change value of order temperature without pass to programming mode.

QUICK CHANGE VALUE OF WORK TEMPERATURE

If you need change work mode in standard work you need push button MODE, next follow with instructions as select work mode which is presented in programming mode section.

QUICK CHANGE OF ORDERED VALUE

To change ordered value of temperature in standard work of regulator use buttons "UP" or "DOWN". Pushing once time button "UP" cause increase ordered temperature by 0,5°C, but pushing button "DOWN" cause fall ordered temperature by 0,5°C.

Increases temperature higher than default value is signalize by display in upper line a sign \uparrow , but fall temperature is signalize by sign \downarrow .

ATTENTION!

Handwork correction of ordered temperature will be force at all next work in automatic mode. Also after start program to next step of program, forced value will be change by value from handwork correction Return to default settings is possible in causes:

- handwork configuration to moment when arrow will disappear from display.
- reconnection regulator to continuous work mode.,

Example of quick configuration of ordered temperature

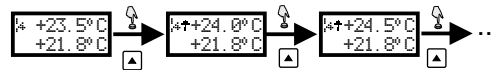

DISPLAY ACTUAL DATE AND TIME

Display to date and time, need to in standard work of regulator push button OK..

07:32 Fr
01.02.08

After 3 sec. regulator return to earlier window.

ERRORS SYGNALING

In the cause break or wrong work of sensor, regulator display underline report:

\downarrow +23.5°C
Sensor!

In this cause first of all need to check connection of sensor.

TECHNICAL DATA

PROBE RT4

sensor	DS18S20
dimensions of sensor	Ø5; h=30mm
sensor isolation	therm jacket
cable	LiYY 3x0,34mm, l=2,5m

CRT-04

supply	230V AC
current load	<16A
joint	separated 1P
range of regulation temperature	0+60°C
hysteresis setting range	0+10°C
precision	0,1°C
model correction	±5°C
delay reconnection- to set	1+15min
power consumption	1,5W
working temperature	-20+40°C
terminal	screw terminals 2,5mm ²
dimensions	3 modules (52,5mm)
fixing	on rail TH-35

ASSEMBLY:

1. Take OFF the power.
2. Regulator put on the rail in the switchgearbox.
3. Connect supply: L to joint 1; N to joint 2.
4. Out cable of temperature probe connect to really with marks WHITE cable(7) to joint 8, BROWN cable (9) to joint 9.
5. System of enclosure receiver connect in line to joints 11-12
6. Set program to regulation temperature.

ATTENTION!

For use seprtated reconnection of joint 1P, were accept in instruction configuration:

JOINT	pos. 11-10	pos. 11-12
OPEN	open	close
CLOSE	close	open

WIRING DIAGRAM

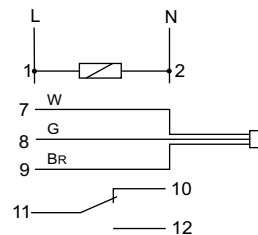

ATTENTION!

Do not any change in device. It impend break or wrong work of device, it will cause break contolled device or menace for user. In this cause producer is not responsible of arise accidents and could refuse given warranty for regulator in cause submit a claim.