



F&F Filipowski sp. j.
Konstantynowska 79/81, 95-200 Pabianice, POLAND
phone/fax (+48 42) 215 23 83 / (+48 42) 227 09 71
www.fif.com.pl; e-mail: biuro@fif.com.pl

PCS-516 DUO

Time relay,
10-function



Do not dispose of this device in the trash along with other waste!

According to the Law on Waste, electro coming from households free of charge and can give any amount to up to that end point of collection, as well as to store the occasion of the purchase of new equipment (in accordance with the principle of old-for-new, regardless of brand). Electro thrown in the trash or abandoned in nature, pose a threat to the environment and human health.



Purpose

The PCS-516 DUO time relay is used for time control in industrial and home automation systems (such as : ventilation, heating, lighting, signaling, etc.).

Features of work

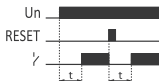

A. ON delay

After the supply voltage is switched on (the green LED U is on), the contact remains in position 11-10 and the set operating time counts down. After the preset time has elapsed, the contact switches to position 11-12 (the red LED λ is on). To execute the operating mode of the relay again you need to switch off the power supply voltage and switch it back on.

(B)

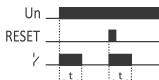

B. OFF delay

The contact remains in position 11-10 until the relay is switched on. After the supply voltage is switched on (the green LED U is on), the contact is switched in position 11-12 and the set operating time t is measured (the red LED γ is on). To execute the operating mode of the relay again you need to switch off the power supply voltage and switch it back on.

(C)



C. ON delay – cyclic

On delay operating mode is carried out cyclically at equal intervals between the preset operating time and break time.

(D)



D. OFF delay – cyclic

Off delay operating mode is carried out cyclically at equal intervals between the preset operating time and break time.

(E)

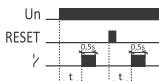

Generating pulse $0.5s$ after the preset time t .

(F)



Generating a single pulse with time t by the rising edge of the **START** signal. During the time measurement, the system does not react to **START** pulses.

(G)

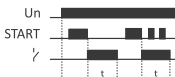

Generating a single pulse with time t by the trailing edge of the **START** signal. During the time measurement, the system does not react to **START** pulses.

(H)

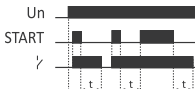

Off delay with back-up feature The rising edge of the **START** signal causes the relay to be switched on, while the trailing edge causes the start of time measurement. Applying the **START** signal during the time measurement causes the cycle to be extended

by another time t with the trailing edge.

I

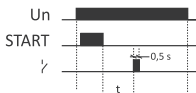

Generating a single pulse 0.5 s after time t with the triggered trailing edge of the **START** signal.

K



Switching off the relay for a specific time t with the rising edge of the **START** signal. During the time measurement, the system does not react to **START** signal.

When the **RESET** voltage is applied during the execution of the given function, it causes:

- » for functions A, B, C, D, F – the implementation of the operating mode from the beginning;
- » for functions F, G, H, I – the return of the relay to the initial state and waiting for the **START** signal;
- » for function K – permanent switching on of the relay contact in position 11-12.

!

Setting the rotary timer switch in position:

- » ON when the power supply is on closes the contact permanently in position 11-12;
- » OFF when the power supply is on closes the contact permanently in position 11-10.



Working time setting

Using the time range setting knob $T \leftrightarrow$, set one of the selected ranges, then using the time setting knob $T \times$, set the selected value on a scale from 1 to 12. The product of these values is equal to the operating time (for example: $1 \text{ m} \times 7 = 7 \text{ min.}$).

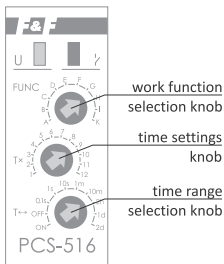

Working mode setting

Using the **FUNC** dial, set one of the functions (for example function A – off delay).



When the power supply of the relay is switched on, the system does not react to the change of time range and working time settings.



Operation with the newly set time range and operating mode takes place after the power supply is switched off and back on.



With the power supply switched on, it is possible to smoothly adjust the time within the time range of 1÷12.

Time ranges

0,1 s:	0.1÷1.2 sec	10 m:	10÷120 min.
1 s:	1÷12 sec	2 h:	2÷24 godz.
10 s:	10÷120 sec	1 d:	1÷12 days (24÷288 h)
1 m:	1÷12 min.	2 d:	2÷24 days (48÷576 h)
ON	when the power supply is on, the contact is permanently closed in position 11-12.		
OFF	when the power supply is on, the contact is permanently closed in position 11-10.		

Mounting

1. Turn off the power supply.
2. Fix the relay on a rail in the switchboard.
3. Connect the power wires according to the as marked: 230 V to terminals 1-3 and 24 V to terminals 1-6.



Connect only one of the selected voltages!

4. Connect the power supply circuit of the receiver in series to terminals 11-12.

Wiring diagram

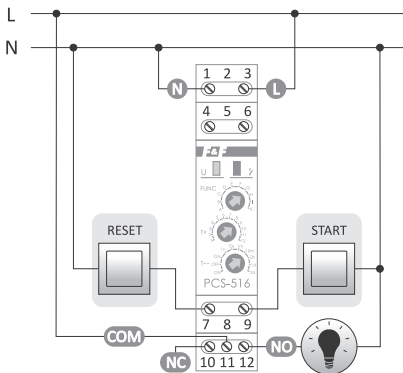

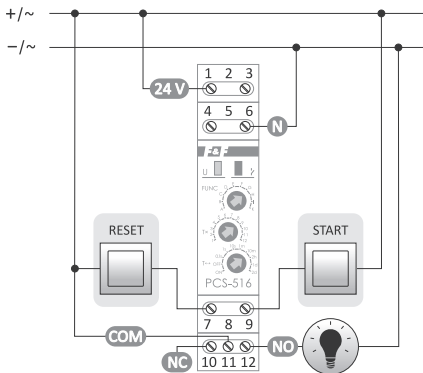

Description of terminals

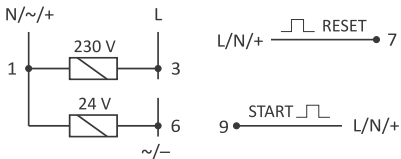

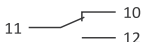

1-3	230 V power supply relay
1-6	24 V power supply relay
7	RESET control signal input
9	START control signal input
11	COM contact power input
10	output: break contact (passive)
12	output: closing contact (active)

Technical data

power supply	195÷253 V AC 21÷27 V AC/DC
maximum load current (AC-1)	8 A
contact	separated 1×NO/NC
working time (adjustable)	0.1 s÷576 h
activation delay	<50 ms
power supply indication	green LED
contacts state indication	red LED
power consumption	0.8 W
terminal	2.5 mm ² screw terminals
tightening torque	0,4 Nm
working temperature	-25÷50°C
dimensions	1 module (18 mm)
mounting	on TH-35 rail
protection level	IP20

Warranty

The F&F products are covered by a warranty of the 24 months from the date of purchase. Effective only with proof of purchase. Contact your dealer or directly with us.

CE declaration

F&F Filipowski sp. j. declares that the device is in conformity with the essential requirements of The Low Voltage Directive (LVD) 2014/35/EU and the Electromagnetic Compatibility (EMC) Directive 2014/30/UE. The CE Declaration of Conformity, along with the references to the standards in relation to which conformity is declared, can be found at www.fif.com.pl on the product page.

«F&F»[®]