



F&F Filipowski sp. j.  
Konstantynowska 79/81, 95-200 Pabianice, POLAND  
phone/fax (+48 42) 215 23 83 / (+48 42) 227 09 71  
www.fif.com.pl; e-mail: biuro@fif.com.pl

## BIS-412-LED

Bistable relay,  
group



**Do not dispose of this device in the trash along with other waste!** According to the Law on Waste, electro coming from households free of charge and can give any amount to up to that end point of collection, as well as to store the occasion of the purchase of new equipment (in accordance with the principle of old-for-new, regardless of brand). Electro thrown in the trash or abandoned in nature, pose a threat to the environment and human health.



### Purpose

Electronic bistable pulse relay BIS-412-LED is designed to work in a group system. The single relay allows you to control the receiver using momentary (bell) buttons, connected to local control inputs. Additionally, thanks to the central control inputs, it is possible to group control of many receivers simultaneously.

### Functioning

The lighting of the green LED marked with the U symbol means that the device is properly powered. The device can be controlled from the level of local and central inputs.

#### Local control

The receiver is turned on (the relay contact is switched to position 7-10) after pressing any momentary button from the local control group. The activation of the receiver is signaled by the lighting of the red LED diode. Another pressing of the button from the local control group will turn off the receiver (the contact returns to position 7-12).

## Central control

SWITCH OFF EVERYTHING (input no. 9) – pressing the momentary button connected to this input will always turn off the receiver (regardless of its previous state). The relay contacts will be switched to position 7-12. This input allows you to centrally control a group of devices with a single button.

SWITCH ON EVERYTHING (input no. 4) – pressing the momentary button connected to this input will always turn on the receiver (regardless of its previous state). The relay contacts will be switched to position 7-10. This input allows you to centrally control a group of devices with a single button.



The "LED" version of the relay is equipped with a contact designed to cooperate with receivers with high starting current, such as: LED fluorescent lamps, ESL fluorescent lamps, electronic transformers, discharge lamps, etc.

---

## Mounting

1. Disconnect the power supply.
  2. Fix the relay on a rail in the control box.
- 



Do not install a device that is damaged or incomplete.

---

3. Connect the power wires to terminals 1-3 according to the diagram.
- 



The group of relays working with common central control must be supplied from the same phase, e.g. only L1.

---



Be especially careful when installing the controller. Incorrect connection may result in electric shock and/or damage to the controller and the powered device.

---

4. Connect the local control and central control switches to the relay terminals in accordance with the function and to the N-wire.

---



Connecting different „zeros“ N to the control inputs of relays may cause incorrect operation of the system and lead to an electrical short circuit in the installation and destruction of the controllers.

---

5. Connect the relay contact in series into the power supply circuit of the controlled receiver/lighting (connect the power to terminal 7; connect the controlled receiver between terminal 10 and N-wire).

6. Connect the power supply.

---



BIS-412-LED is compatible with backlit buttons.

---

### Contact configuration



## Wiring diagram

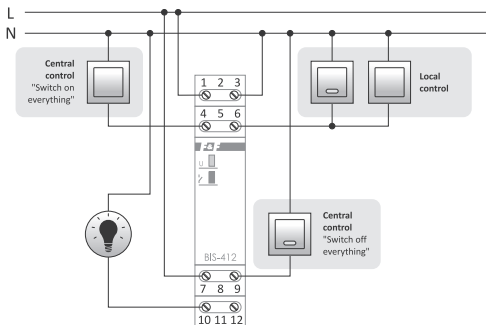

- 1-3 relay power supply 165÷265 V AC
- 4 central control: **SWITCH ON EVERYTHING**
- 6 local control: **ON/OFF**
- 9 central control: **SWITCH OFF EVERYTHING**
- 7-10 1×NO separated contact



The control inputs may only be powered from the neutral wire (N).

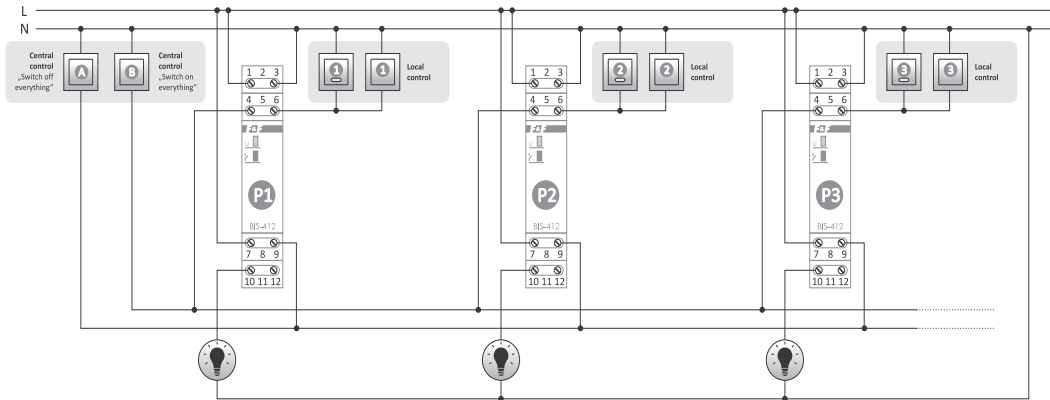

Group system diagram

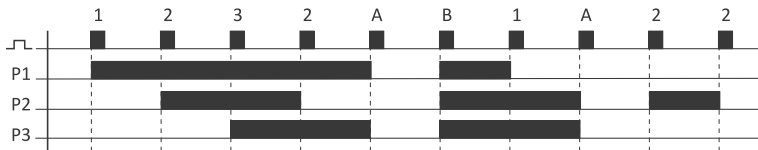







The maximum total backlight current of all connected buttons must not exceed 5 mA.

### Technical data

power supply	165÷265 V AC
contact	separated 1×NO
maximum load current (AC-1)	16 A (120 A/20 ms)
control pulse current	5 mA
activation delay	0.1÷0.2 s
power indication	green LED
signalling indication	red LED
power consumption	
standby	0.15 W
on	0.6 W
terminal	2.5 mm <sup>2</sup> screw terminals
tightening torque	0.4 Nm
working temperature	-25÷50°C
dimensions	1 module (18 mm)
mounting	on TH-35 rail
ingress protection	IP20

## Power table

				
tungsten	halogen	fluorescent	energy-saving	LED
2000 W	1250 W	1000 W	500 W	250 W

The above data are indicative and will heavily depend on the design of a specific receiver (that is especially important for LED bulbs, energy-saving lamps, electronic transformers and pulse power supply units), switching frequency and operating conditions.

For more information visit: [www.fif.com.pl](http://www.fif.com.pl).

## Warranty

The F&F products are covered by a warranty of the 24 months from the date of purchase. Effective only with proof of purchase. Contact your dealer or directly with us.

## CE declaration

F&F Filipowski sp. j. declares that the device is in conformity with the essential requirements of The Low Voltage Directive (LVD) 2014/35/EU and the Electromagnetic Compatibility (EMC) Directive 2014/30/UE.

The CE Declaration of Conformity, along with the references to the standards in relation to which conformity is declared, can be found at [www.fif.com.pl](http://www.fif.com.pl) on the product page.