

LE-03MB CT

Electric energy meter

1-phase / 3-phase

Bidirectional with network parameters analysis



User manual
v. 4.7 (230911)

CONTENTS

1. PURPOSE.....	4
2. UNIT CHARACTERISTICS.....	4
2.1. Measured value	4
2.2. Current transformers (CT)	4
2.3. M-Bus protocole and communication port	5
2.4. Pulse output	5
3. START-UP SCREENS.....	5
4. OPERATOR PANEL.....	6
4.1. Voltage and current, harmonic	6
4.2. Frequency, power factor and demand	7
4.3. Power	8
4.4. Energy measurements	9
5. SETUP.....	10
5.1. Setup entry methods	10
5.2. Setup parameters	11
6. TECHNICAL SPECIFICATION.....	23
6.1. Measured parameters	23
6.2. Terminal	24
6.3. Accuracy	24
6.4. Power supply and power meter	24
6.5. Measurement inputs	24
6.6. Pulse outputs	25
6.7. M-Bus output	25
6.8. Reference conditions of influence quantities	25
6.9. Environment	26
6.10. Structure	26
6.11. Compliance and sealing	26
7. DIMENSIONS	27

8. WIRING DIAGRAM.....	27
9. M-BUS PROTOCOLE.....	28
9.1. Initialization Slave.....	28
9.2. How to set baud rate	29
9.3. How to set primary address.....	30
9.4. Set the complete identification of the Slave	31
9.5. How to read out of energy information	32
9.6. Read out of instantaneous electrical information	35
9.7. How to read password.....	41
9.8. How to reset all resettable energy data.....	41
9.9. Set demand interval, slide time, display time, LED time.....	41
9.10. Read demand interval, slide time, display time, LED time.....	41
9.11. Read the measurement mode	43
9.12. Set up the measurement mode	43
9.13. Read the output mode of pulse 1	43
9.14. Set up the output mode of pulse 1.....	44
9.15. Read the constant of pulse 1	44
9.16. Set up the constant of pulse 1.....	44
10. MANUFACTURER'S WARRANTY	45

1. Purpose

LE-03MB CT is a static (electronic), calibrated electricity meter of single-phase and three-phase alternating current in direct system. It is used for reading and recording of imported electricity and parameters of the power supply with the ability of remote reading through a wired M-Bus network. The meter works with current transformers (CT) with 1 A or 5 A secondary current. Configuration of the meter is done through the configuration menu accessible from the front panel and through the communication port according to the software features of the M-Bus.

2. Unit characteristics

2.1. Measured value

The unit can measure and display:

- ✓ Line voltage and THD% (total harmonic distortion) of all phases;
- ✓ Line frequency;
- ✓ Currents, current demands and current THD% of all phases;
- ✓ Power, maximum power demand and power factor;
- ✓ Active energy imported and exported;
- ✓ Reactive energy imported and exported.

2.2. Current transformers (CT)

The meter works with current transformers (CT) with 1 A or 5 A secondary current. The appropriate value of rate and the secondary current of the connected transformer should be set in the meter.

For example: using a 100/5 A current transformer, you should set the secondary current CT2 to 5 and the rate CTrate to 0020. To get the CT rate to enter you need to divide a primary current value by the value of the secondary current ($100/5 = 20$).

WARNING!

The settings for the current ratio (CT2 and CT rate) and voltage ratio (PT2 and PT rate) can only be made once. It is a legal requirement of the MID Directive. Once set the rate cannot be changed.

2.3. M-Bus protocole and communication port

Meter has a port with support for M-Bus protocol.

The M-Bus communication port allows you to combine the counters in the remote reading network.

2.4. Pulse output

The meter has two pulse outputs for mapping the counting of active and reactive energy.

Output 1 - terminals 9/10 - programmable, can be set to work for active or reactive energy and parameters: impulsing and pulse length.

Output 2 - terminals 11/12 - for active energy, impulsing is 3200 pulse / kWh.

3. Start-up screens

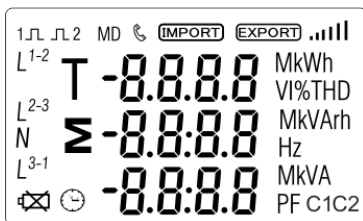

The first screen lights up all display segments and can be used as a display check.



Information about software version.



The interface performs a self-test and indicates the result if the test passes.

4. Operator panel

Buttons features:



Select the voltage and current display screens. In set up mode, this is the "Left" or "Back" button.



Select the frequency and power factor display screens. In set up mode, this is the "Up" button.



Select the power display screens. In set up mode, this is the "Down" button.



Select the energy display screens. In set up mode, this is the "Enter" or "Right" button.

4.1. Voltage and current, harmonic

Each successive pressing of the  button select a new range:



Phase to neutral voltages



Current on each phase

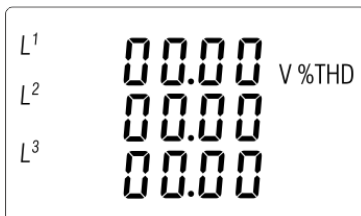

Phase to neutral voltage THD%



Current THD% for each phase

4.2. Frequency, power factor and demand

Each successive pressing of the  button selects a new range:

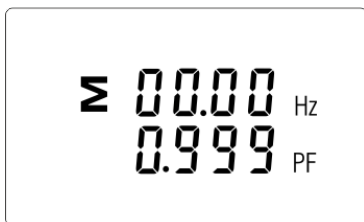

Frequency and power factor (total)

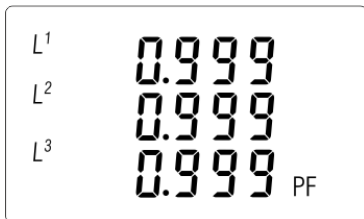

Power factor of each phase



Maximum power demand



Maximum current demand

4.3. Power

Each successive pressing of the  button select a new range:



Instantaneous active power in kW



Instantaneous reactive power in kVAr

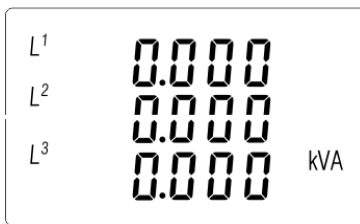

Instantaneous Volt-amps in KVA

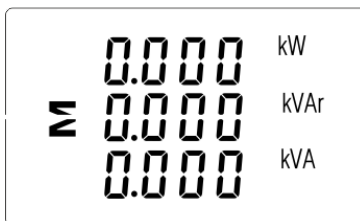

Total: kW, kvar, kVA

4.4. Energy measurements

Each successive pressing of the  button select a new range:

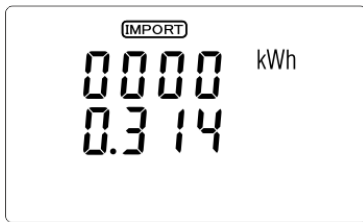

Imported active energy in kWh



Exported active energy in kWh



Imported reactive energy in kVArh



Exported reactive energy in kVArh

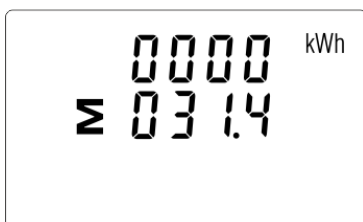

Total active energy in kWh



Total reactive energy in kVArh

The total value of the given energy is presented in two rows.

The top row presents the higher values, the bottom row presents the lower values + fractional value. For example:











Indications: 0027 - top row; 845.3 - bottom row presents the value of 27845.3 kWh

5. Setup

5.1. Setup entry methods





Some menu items, such as password and CT, require a four-digit number entry while others, such as supply system, require selection from a number of menu options. After confirming the settings the meter confirms the adoption of a new parameter by displaying for a moment the word "good".

5.1.1. Navigation

1.   Transition to the next position configuration menu.
2. Press  to confirm your selection.
3.   Edition of value (change of position number by +/-1)
4. Having selected an option from the current layer, press  to confirm your selection. The SET indicator will appear.
5.  Back to the higher menu level. The SET indicator will disappear and you will be able to use the buttons,   again to select further options.
6.  Exit the configuration menu to the measurements screen.

5.1.2. Number entry procedure

When setting up the unit, some screens require the entering of a number. In particular, on entry to the setting up section, a password must be entered. Digits are set individually, from left to right. The procedure is as follows:

1. The current digit to be set flashes and is set using the  and  buttons.
2. Press  to confirm each digit setting. The SET indicator appears the last digit has been set.
3. After setting the last digit, press , to exit the number setting routine. The SET indicator will be removed.

5.2. Setup parameters

5.2.1. Entry into configuration menu

To enter setup mode, pressing the  button for 2 seconds, until the password screen appears.



Setting up is password-protected so you must enter the correct password (default "1000") before processing.

Press the  button for 2 seconds.

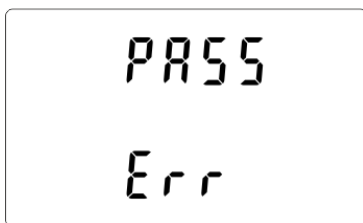

If an incorrect password is entered, the display will show:

PASS Err

To exit setting-up mode, press  repeatedly until the measurement screen is restored.

5.2.2. M-Bus communication



Setting the communication port parameters.

5.2.2.1. (Slave ID) Address

(Range 1 to 250)



From the set up menu, use

 and , buttons to select the address ID.



Press , button to enter the selection routine. The current setting will be flashing.



Use **P** and **MD/PF/HZ** to change digits and **E** to change position, to choose M-Bus address (001 to 250).

Press **E** button, to confirm the selection.

Press **V/A ESC** button to return the main set up menu.

Extended address (Range 0 to 99999999).

ATTENTION!

This setting is located in the menu before the CLR feature setting.



From the setup menu, use **P** and **MD/PF/HZ** buttons to select extended address option.



Press **E** button to enter the selection routine. The current setting will be flashing.





Use **P** and **MD/PF/HZ** buttons to change digits and **E** to change position, to choose M-Bus address (00000000 to 99999999).

Press **E** button to confirm the selection.

Press **V/A ESC** button to return the main set up menu.

5.2.2.2. Baud rate







From the set up menu, use  and  buttons to select the Baud rate option.



Press  button to enter the selection routine. The current setting will flash.





Use  and  buttons to choose Baud rate: 0.3 / 0.6 / 1.2 / 2.4 / 4.8 / 9.6 [kbps].
Press  button, to confirm the selection.

Press  button, to return the main set up menu.

5.2.2.3. Parity



From the set up menu, use  and  buttons to select the parity option.



Press  to enter the selection routine. The current setting will flash.



Use **P** and **MD/ PF/HZ** buttons to choose parity: EVEN / ODD / NONE (default).
 Press **E** button to confirm selection.

Press **V/A ESC** button to return to the main set up menu.

5.2.2.4. Stop bits

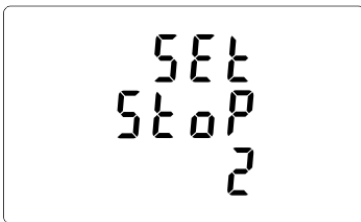

From the set up menu, use **P** and **MD/ PF/HZ** buttons to select the stop bit option.



Press **E** to enter the selection routine.
 The current setting will flash.





Use **P** and **MD/ PF/HZ** buttons to choose stop bits: 2 or 1.
 NOTE: Default value is 1. Only in case parity set up NONE, to change stop bits to 2.
 Press **E** to confirm the selection.

Press **V/A ESC** to return to the main set up menu.

5.2.3. Current transformers

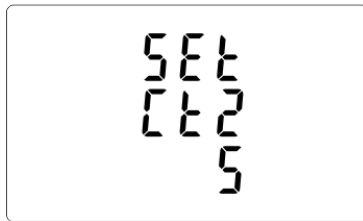
Setting currents values of the connected transformers.



Use the   buttons in the configuration menu to select the value of the CT.

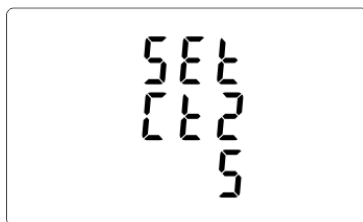

Secondary current.

Hold down  to enter the secondary current setting mode: 5A/1A.

Hold down  to confirm selection.



CT rate.

Hold down  to display the rate setting screen. Range of 0001 to 9999.

Hold down  to confirm selection.

For example: using a 100/5 A current transformer, you should set the secondary current CT2 to 5 and the rate CTRate to 20. To get the CT rate to enter you need to divide a primary current value by the value of the secondary current ($100/5 = 20$).

WARNING!



The settings for the current ratio (CT2 and CT rate) and voltage ratio (PT2 and PT rate) can only be made once. It is a legal requirement of the MID Directive. Once set the rate cannot be changed.

5.2.4. Measurement voltage

Setting the value of the input voltage directly or through transformers.

For half-indirect 1- or 3-phase measurement set the value PT2 to 400 and PTrate to 1.



Use the   buttons in the configuration menu to select the value of the PT.



Input voltage.

Press  to display the rate setting PT2 screen.
Range of 100 to 500 V.

Hold down  to confirm selection.

For half indirect measurement

1- or 3-phase set value PT2 to 400.

PT gear.

Press  to display the rate setting PTrate screen.
Range of 0001 to 9999.

Hold down  to confirm selection.

For half indirect measurement

1- or 3-phase set value PTrate to 1.





5.2.5. Pulse output

Pulse output configuration no. 1.

5.2.5.1. Energy setup

The output can be set to provide a pulse for a defined amount of Energy active (kWh) or reactive (kvarh).







From the setup menu, use  and  buttons to select the pulse output option.



Press  to enter the selection routine.
The unit symbol will be flash.



Use  and  buttons to choose kWh or kvarh.
Press  to confirm selection.

Press  to return to the main set up menu.

5.2.5.2. Pulse rate

Setup value option kWh/kvarh per 1 pulse. Values: 0.01 / 0.1 / 110 / 100.



From the setup menu, use **P** and **MD/ PF/HZ** buttons to select the pulse rate option.



Press **E** to enter the selection routine. The current setting will flash.

Use **P** and **MD/ PF/HZ** buttons to select value: 0.01 / 0.1 / 1 / 10 / 100 per 1 pulse.

Press **E** to confirm selection.

Press **V/A ESC** to return to the main set up menu.

5.2.5.3. Pulse duration

Option of setting pulse length for output. Values: 200, 100 lub 60 msec.



From the setup menu, use **P** and **MD/ PF/HZ** buttons to select the pulse width option.



Press **E** to enter the selection routine. The current setting will flash.

Use **P** and **MD/ PF/HZ** buttons to choose value: 200, 100 or 60 msec.



Press **E** to confirm the selection.

Press **V/A ESC** to return to the main setup menu.

5.2.6. DIT - Demand Integration Time

The options are: 5, 10, 15, 30, 60 minutes.





From the setup menu, use  and  buttons, to select the DIT option.
The screen will show the currently selected integration time.



Press  to enter the selection routine.
The current time interval will flash.



Use  and  buttons to select the time required.



Press  to confirm selection.
SET indicator will appear.

Press  to exit the DIT selection routine and return to the menu.

5.2.7. Backlit setup

The meter allows you to set the time of the backlight.



Time: 0 / 5 / 10 / 30 / 60 / 120 minutes.

Value 0 means that the backlight is always on.



Default lasting time is 60 minutes.
if it's setted as 5, the backlit will be off in 5 minutes from the last time operation on the meter.



Use  and  buttons to select the time.
Press  to confirm the selection.

5.2.8. Measuring system



Setting options for measuring system:

1P2W – 1-phase 2-wire system;

3P3W – 3-phase 3-wire system (without neutral wire);

3P4W – 3-phase 4-wire system





From the set up menu, use  and  buttons to select the system option.
The screen will show the currently selected power supply.





Press  to enter the selection routine.
The current selection will flash.



Use  and  buttons to select the required system option: 1P2W, 3P3W, 3P4W.





Press  to confirm selection.
SET indicator will appear.

Press  to exit the system selection routine and return to the menu.
SET will disappear and you will be returned to the main set up menu.

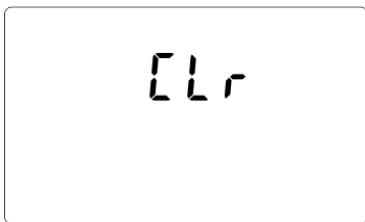

5.2.9. CLR

The meter provides a function to reset the maximum demand value of current and power.

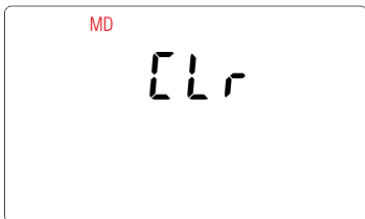

From the setup menu, use  and  buttons to select the reset option.



Press  to enter the selection routine.
The MD will flash.
Press  to confirm selection.

Press  to return to the main set up menu.

5.2.10. Change password

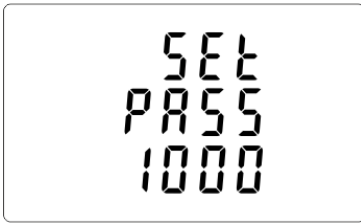

Press **P** and **MD/PF/HZ** buttons to choose the change password option.



Press and hold **E** to enter the change password routine. The new password screen will appear with the first digit flashing.



Use **P** and **MD/PF/HZ** buttons to set the first digit and press **E** to confirm your selection. The next digit will flash.



Repeat the procedure for the remaining three digits.

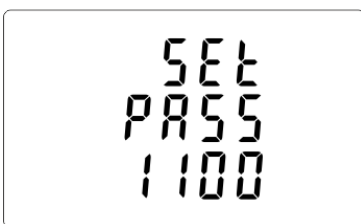

After setting the last digit, press and hold **E** to confirm selection.

Press **V/A ESC** to exit the numer setting routine and return to the setup menu. SET will be removed.

6. Technical specification

6.1. Measured parameters

The unit can monitor and display the following parameters of:

1P2W – 1-phase 2-wire system (230V+N)

3P3W – 3-phase 3-wire system (3×400V; without neutral wire)

3P4W – 3-phase 4-wire system (3×230V+N)

6.1.1. Voltages and currents

Reference voltage:	3×230/400V
Base current:	0.25÷10A
Maximum current:	100A
Minimum current measured:	0.02A
Overload:	30×I _{max} /10msec
Measuring range phase voltages:	100÷289 VAC (for 1P2W and 3P4W system)
Range of interphase voltages:	173÷500 VAC (for 3P3W system)
Percentage overall factor of total harmonic distortion (THD%) for the phase voltages (for systems 1P2W and 3P4W).	
Percentage overall factor of total harmonic distortion (THD%) for interphase voltages (for 3P3W system).	
Percentage overall factor of total harmonic distortion (THD%) for the phase currents.	
Insulation: 4kV/1min; 6kV/1,2μs	

6.1.2. Power factor, frequency and maximum demand

- ✓ Frequency in Hz
- ✓ Instantaneous power:
 - active: 0÷3600 MW
 - reactive: 0÷3600 Mvar
 - pozorna: 0÷3600 MVA
- ✓ Maximum power consumption (with RESET function)
- ✓ Maximum power consumption neutral wire (with RESET function)

6.1.3. Energy measurements

- ✓ Imported/exported active energy: 0÷9999999.9 kWh
- ✓ Imported/exported reactive energy: 0÷9999999.9 kvarh
- ✓ Total active energy: 0÷9999999.9 kWh
- ✓ Total reactive energy: 0÷9999999.9 kvarh

6.2. Terminal

Current inputs	2.5mm ² screw terminals
Voltage inputs	2.5mm ² screw terminals
Pulse outputs	2.5mm ² screw terminals
M-Bus port	2.5mm ² screw terminals

6.3. Accuracy

Measurement class	1
Voltage	0.5% of range maximum
Current	0.5% of nominal
Frequency	0.2% of mid-frequency
Power factor	1% of unity (0.01)
Active power [W]	±1% of range maximum
Reactive power [VAr]	±1% of range maximum
Apparent power [VA]	±1% of range maximum
Active energy [Wh] (IEC 62053-21)	±1% 1
Reactive energy [VArh]	±1% of range maximum
Total harmonic distortion	1% up to 31st harmonic
Response time to step input	1s, typical, to >99% of final reading at 50 Hz.

6.4. Power supply and power meter

85÷275 V AC 50/60 Hz ±10%
120÷380 V DC ±20%
<10VA; <2W

6.5. Measurement inputs

Voltage: 3×230V/400V
Current: 6A < 1VA

6.6. Pulse outputs

Output type: OC (open collector); 27V DC/50mA

Pulse:

Pulse output 1 is configurable: for kWh or kvarh. Value set kWh/kvarh per 1 pulse:

0.01 = 10 Wh/VArh

0.1 = 100 Wh/VArh

1 = 1 kWh/kVArh

10 = 10 kWh/kVArh

100 = 100 kWh/kVArh

1000 = 1000 kWh/kVArh

Pulse output 2 is non-configurable for kWh: 3200pulse/kWh

Pulse width:

Output 1 - configurable: 200 / 100 / 60 ms

Output 2 - non-configurable: 200ms

6.7. M-Bus output

Baud rate: 300, 600, 1200, 2400, 4800, 9600 bps

Parity: NONE - default / ODD / EVEN

Stop bits: 1 / 2

Network address: basic 1÷250, expanded 0÷99999999;

6.8. Reference conditions of influence quantities

Influence quantities are variables that effect measurement errors to a minor degree. Accuracy is verified under nominal value (within the specified tolerance) of these conditions.

Ambient temperature	23°C ±1°C
Input frequency	50 or 60 Hz ±2%
Input waveform	sinusoidal (distortion factor <0.005)
Auxiliary supply voltage	±1% nominal
Auxiliary supply frequency	±1% nominal
Auxiliary supply waveform (if AC)	sinusoidal (distortion factor <0.05)
Magnetic field of external origin	terrestrial flux

6.9. Environment

Operating temperature	-25÷55°C
Storage temperature	-40÷70°C
Relative humidity	0÷95%, non-condensing
Altitude	Up to 3000 m
Warm up time	1 minute
Vibration	10÷50Hz, IEC 60068-2-6, 2 g
Limitation	30g in 3 planes

6.10. Structure

Mounting	on DIN rail
Cover	UI94 V-0 self-extinguishing material
Ingress protection	IP51 (inside)

6.11. Compliance and sealing

LVD 2014/35/UE Directive.

The meter is marked with individual serial number allowing its explicit identification.
The marking is laser engraved and cannot be removed.

The meter has sealable input and output terminal cover to prevent any attempts to bypass the meter.

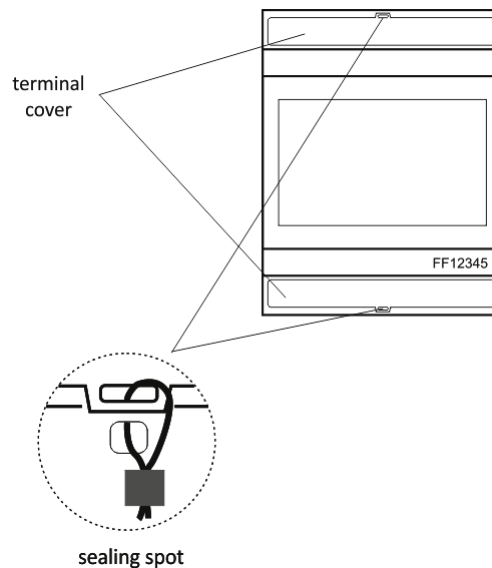

7. Dimensions

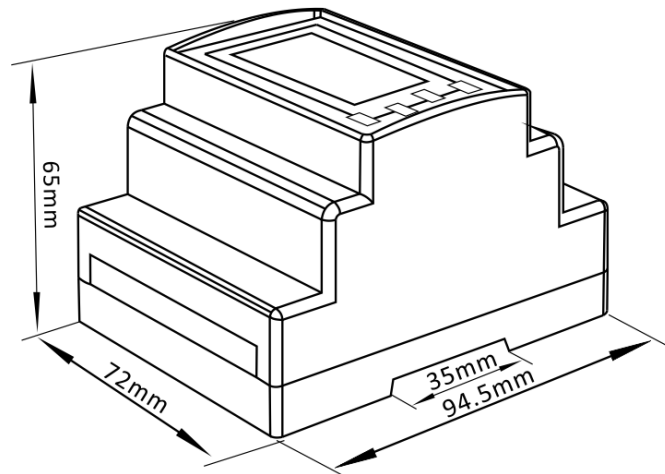

8. Wiring diagram

1-phase 2-wire system

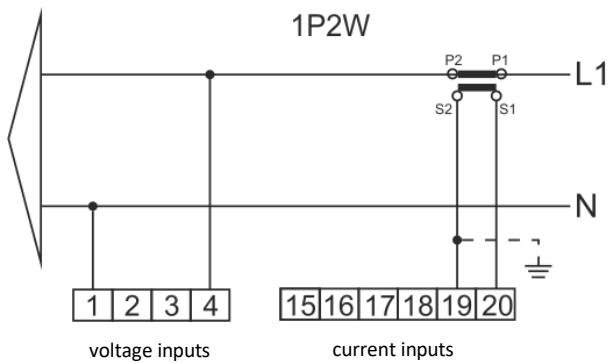

3-phase 3-wire system

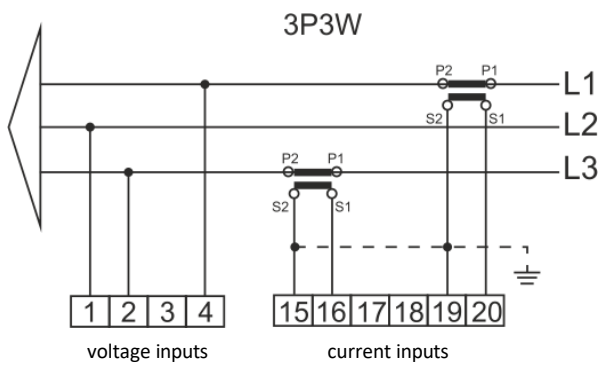

3-phase 4-wire system

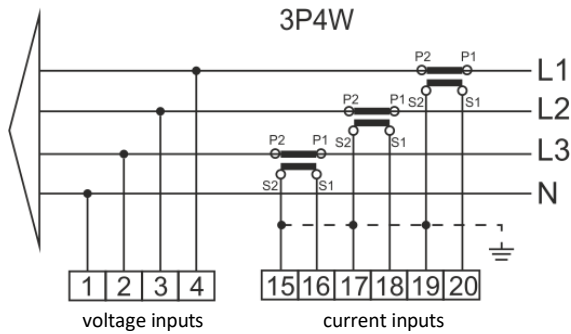

Current and voltage inputs

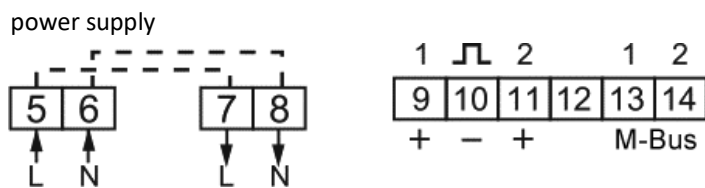

9. M-Bus protocole

9.1. Initialization Slave

Format:

Start	C field	A field	Check sum	Stop
10	40	XX	CS	16

XX=1 to FF

The address field serves to address the recipient in the calling direction, and to identify the sender of information in the receiving direction. The size of this field is one byte, and can therefore take values from 0 to 255. The addresses 1 to 250 can be allocated to the individual slaves, up to a maximum of 250..

Unconfigured slaves are given the address 0 at manufacture, and as a rule are allocated one of these addresses when connected to the M-Bus. The addresses 254 (FE) and 255 (FF) are used to transmit information to all participants (Broadcast). With address 255 none of the slaves reply, and with address 254 all slaves reply with their own addresses. The latter case naturally results in collisions when two or more slaves are connected, and should only be used for test purposes. The address 253 (FD) indicates that the addressing has been performed in the Network Layer instead of Data Link Layer, the FD used when using the second level address. The remaining addresses 251 and 252 have been kept for future applications.

9.1.1. How to initialize a meter which you don't know the address

Master to Slave: 10 40 FE 3E 16
 Slave to Master: E5 (success)

9.1.2. Remove the secondary address matching symbol of all the meters on Bus

Master to Slave: 10 40 FD 3D 16
 Slave: No answer

9.1.3. How to initialize all meters on the bus line by using FF as broadcast address

Master to Slave: 10 40 FF 3F 16
 Slave: No answer

9.1.4. How to initialize a Slave with specific address

Example: address 01
 Master to Slave: 10 40 01 41 16
 Slave to Master: E5

9.2. How to initialize a Slave with specific address

9.2.1. Point to point baud-rate setting command format (Control frame)

Start	L field	L field	Start	C field	A field	CI field	Check sum	Stop
68H	03	03	68H	53/73	FE	B8-BD	CS	16

L field - Byte length
 C field - Control field, function field
 A field - Address field
 CI field - Control information field
 Check sum - The Check sum is calculated from the arithmetical sum of the data mentioned above, without taking carry digits into account.

B8 ----- 300
 B9 ----- 600
 BA ----- 1200
 BB ----- 2400
 BC ----- 4800
 BD ----- 9600

Example:

(1) How to change baud rate to 2400 bps.

Master to Slave: 68 03 03 68 53 FE BB 0C 16
 Slave to Master: E5

(2) How to change baud rate to 9600 bps.

Master to Slave: 68 03 03 68 53 FE BD 0C 16
 Slave to Master: E5

9.2.2. How to use broadcast command to set baud rate

Format:

Start	L field	L field	Start	C field	A field	CI field	Check sum	Stop
68H	03	03	68H	53/73	FF	B8-BD	CS	16

Slave to Master: **No answer**

B8-----300
 B9-----600
 BA-----1200
 BB-----2400
 BC-----4800
 BD-----9600

Example:

Change all the meter's baud rate to 2400 bps.

Master to Slave: 68 03 03 68 53 **FF** BB 0D 16

Slave to Master: No answer

9.3. How to set primary address

9.3.1. How to set the address of a Slave to 01

Format:

Start	L field	L field	Start	C field	A field	CI field	DIF	VIF	Address data	Check sum	Stop
68H	06	06	68H	53/73	FE	51	01	7A	XX	CS	16

Example:

Master to Slave: 68 06 06 68 53 FE 51 01 7A **01** 1E 16

Slave to Master: E5

9.3.2. How to use broadcast command to set primary address to 01

Format:

Start	L field	L field	Start	C field	A field	CI field	DIF	VIF	Address data	Check sum	Stop
68H	06	06	68H	53/73	FF	51	01	7A	XX	CS	16

Example:

Master to Slave: 68 06 06 68 53 **FF** 51 01 7A **01** 1F 16

Slave: No answer

9.3.3. How to change address from 01 to 02

Format:

Start	L field	L field	Start	C field	A field	CI field	DIF	VIF	Address data	Check sum	Stop
68H	06	06	68H	53/73	XX	51	01	7A	YY	CS	16

XX - current primary address

YY - new primary address

Master to Slave: 68 06 06 68 73 01 51 01 7A 02 42 16

Slave to Master: E5

9.3.4. How to set primary address to 01 by using secondary address

Example: secondary address: 12345678

Step 1

Initialize the Slave

Master to Slave: 10 40 FE 3E 16

Slave to Master: E5

Step 2

Check the secondary address. After receiving the command, the Slave will check if the secondary address in the command is same with its secondary address or not.

Master to Slave: 68 0B 68 73 FD 52 78 56 34 12 FF FF FF FF D2 16

FD --- the primary address used when you use secondary address to read data.

78 56 34 12 - the meter's secondary address is 12 34 56 78

Master to Slave: E5 (success)

Step 3

Change the primary address to 01

Master to Slave: 68 06 06 68 73 FD 51 01 7A 01 3D

01 --- new primary address

Slave to Master: E5

9.4. Set the complete identification of the Slave

(ID=12345678, Man=4024h (PAD), Gen=1, Med=02 (energy))

Start	L field	L field	Start	C field	A field	CI field	DIF	VIF
68H	0D	0D	68H	53/73	FE	51	07	79

Identification No	Manufacturer ID	Generation	Medium	Check sum	Stop
4 byte	2 byte	1 byte	1 byte	CS	16

Master to Slave: 68 0D 0D 68 53 FE 51 07 79 78 56 34 12 24 40 01 02 9D 16

Slave to Master: E5

9.5. How to read out of energy information

9.5.1. Use primary address 01 to read energy information

Format:

Master to Slave: 10 7B/5B adr CS 16
Slave to Master: Variable data structure
Example: 10 7B 01 7C 16

9.5.2. How to read out a meter's energy information by using broadcast address 254 (FE)

Master to Slave: 10 7B/5B FE CS 16
Slave to Master: Variable data structure
Example: 10 5B FE 59 16

9.5.3. How to read out the meter's energy information by using secondary address

Example:
Secondary address: 12 34 56 78

Step 1

Initialize the Slave

Master to Slave: 10 40 FF 3F 16
Slave to Master: No answer

Step 2

Check the secondary address. After receiving the command, the slave will check if the secondary address in the command is same with its secondary address or not.

Master to Slave: 68 0B 0B 68 73 FD 52 78 56 34 12 FF FF FF FF D2 16
Slave to Master: E5

Step 3

Read the energy information

Master to Slave: 10 7B FD 78 16
Slave to Master: DIF====Coding of the Data Information Field
VIF====Codes for Value Information Field

Bytes	Parameters	Data structure	Notice
4	Header telegram	68 5D 5D 68	Header of RSP_UD telegram
3		08 A 72	C field=08 address A CI field 72
4		78 65 34 21	Identification number =12345678
2		24 40	Manufacturer ID 4024
1		01	Generation 1
1		02	Energy meter
1		55	ACCESS NO
1		00	STATUS
2		00 00	Signature
6		Current total active energy	0C
	04		VIF: 10 W (0.01 kW)
	78 56 34 12		123456.78 kWh
7	Current import active energy	0C	DIF: 8 digit BCDFIE, Current value
		04	VIF: 10 W (0.01 kW)
		78 56 34 12	123456.78 kWh
7	Current export active energy	0C	DIF: 8 digit BCDFIE, Current value
		04	VIF: 10 W (0.01 kW)
		78 56 34 12	123456.78 kWh
6	Current resettable total active energy	0C	DIF: 8 digit BCD, Current value
		04	VIF: 10 W (0.01 kW)
		78 56 34 12	123456.78 kWh
7	Current resettable import active energy	0C	DIF: 8 digit BCDFIE, Current value
		04	VIF: 10 W (0.01 kW)
		78 56 34 12	123456.78 kWh
7	Current resettable export active energy	0C	DIF: 8 digit BCDFIE, Current value
		04	VIF: 10 W (0.01 kW)
		78 56 34 12	123456.78 kWh

Bytes	Parameters	Data structure	Notice
7	Current total reactive energy	0C	DIF: 8 digit BCD, Current value
		FD	VIF: FD
		3A	VIFE: dimensionless / no VIF
		78 56 34 12	123456.78 kVarh
8	Current import reactive energy	0C	DIF: 8 digit BCD FIE, Current value
		FD	VIF: FD
		3A	VIFE: dimensionless / no VIF
		78 56 34 12	123456.78 kVarh
8	Current export reactive energy	8C	DIF: 8 digit BCD FIE, Current value
		FD	VIF: FD
		3A	VIFE: dimensionless / no VIF
		78 56 34 12	123456.78 kVarh
7	Current total resettable reactive energy	0C	DIF: 8 digit BCD, Current value
		FD	VIF: FD
		3A	VIFE: dimensionless / no VIF
		78 56 34 12	123456.78 kVarh
8	Current resettable import reactive energy	0C	DIF: 8 digit BCD FIE, Current value
		FD	VIF: FD
		3A	VIFE: dimensionless / no VIF
		78 56 34 12	123456.78 kVar
8	Current resettable export reactive energy	0C	DIF: 8 digit BCD FIE, Current value
		FD	VIF: FD
		3A	VIFE: dimensionless / no VIF
		78 56 34 12	123456.78 kVar
1	CHECK SUM	CS	
1	End	16	

9.6. Read out of instantaneous electrical information

The instantaneous electrical information includes:

V, I, P, Q, S, PF, Hz ect. MD

9.6.1. How to read instantaneous electrical information by using primary address

Start	L field	L field	Start	C field	A field	Cl field	Check sum	Stop
68H	3	3	68	53/73	XX	B1	CS	16

Master to Slave: 68 03 03 68 53 **XX** B1 05 16

Slave to Master: Variable data structure (instantaneous electrical information)

If the primary address is 01, then XX=01

9.6.2. How to use secondary address to read out the instantaneous electrical information

Step 1

Initialization Slave

Master to Slave: 10 40 FF 3F 16

Slave to Master: No answer

Step 2

Check the secondary address.

After receiving the command, the slave will check if the secondary address in the command is same with its secondary address or not.

Master to Slave: 68 0B 0B 68 73 FD 52 78 56 34 12 FF FF FF FF D2 16

Slave to Master: E5

Step 3

Use Secondary Address to read out the instantaneous electrical information

Master to Slave: 68 03 03 68 53 **FD** B1 01 16

Slave to Master: Variable data structure

Bytes	Parameters	Data structure	Notice
4	Header telegram	68 90 90 68	Header of RSP_UD telegram
3		08 A 72	C field =08 address A CI field 72
4		78 65 34 21	Identification number =12345678
2		24 40	Manufacturer ID 4024
1		01	Generation 1
1		02	Energy meter
1		55	ACCESS NO
1		00	STATUS
2		00 00	Signature
6		L1 voltage	0B
	FD		VIF: FD
	47		VIFE: 0.01 V
	56 34 12		1234.56 V
6	L2 voltage	0B	DIF: 6 digit BCD
		FD	VIF: FD
		47	VIFE: 0.01 V
		56 34 12	1234.56 V
6	L3 voltage	0B	DIF: 6 digit BCD
		FD	VIF: FD
		47	VIFE: 0.01 V
		56 34 12	1234.56 V
6	L1 - L2 Voltage	0B	DIF: 6 digit BCD
		FD	VIF: FD
		47	VIFE: 0.01 V
		56 34 12	1234.56 V

Bytes	Parameters	Data structure	Notice
6	L2 - L3 Voltage	0B	DIF: 6 digit BCD
		FD	VIF: FD
		47	VIFE: 0.01 V
		56 34 12	1234.56 V
6	L3 - L1 Voltage	0B	DIF: 6 digit BCD
		FD	VIF: FD
		47	VIFE: 0.01 V
		56 34 12	1234.56 V
6	L1 current	0B	DIF: 6 digit BCD
		FD	VIF: FD
		59	VIFE: 1 mA (xxx.xxx A)
		56 34 12	123456 mA (123.456 A)
6	L2 current	0B	DIF: 6 digit BCD
		FD	VIF: FD
		59	VIFE: 1 mA (xxx.xxx A)
		56 34 12	123456 mA (123.456 A)
6	L3 current	0B	DIF: 6 digit BCD
		FD	VIF: FD
		59	VIFE: 1 mA (xxx.xxx A)
		56 34 12	123456 mA (123.456 A)
6	N current	0B	DIF: 6 digit BCD
		FD	VIF: FD
		59	VIFE: 1 mA (xxx.xxx A)
		56 34 12	123456mA (123.456A)
5	Total active power	0B	DIF: 6 digit BCD
		2A	VIF: 0.1 W (xx.xxxx kW)
		56 34 12	12345.6 W (12.3456 kW)

Bytes	Parameters	Data structure	Notice
5	L1 active power	0B	DIF: 6 digit BCD
		2A	VIF: 0.1 W (xx.xxxx kW)
		56 34 12	12345.6 W (12.3456 kW)
5	L2 active power	0B	DIF: 6 digit BCD
		2A	VIF: 0.1 W (xx.xxxx kW)
		56 34 12	12345.6 W (12.3456 kW)
5	L3 active power	0B	DIF: 6 digit BCD
		2A	VIF: 0.1 W (xx.xxxx kW)
		56 34 12	12345.6 W (12.3456 kW)
6	Total reactive power	0B	DIF: 6 digit BCD
		FD	VIF: FD
		3A	VIFE: dimensionless / no VIF
		56 34 12	12345.6 W (12.3456 kW)
6	L1 reactive power	0B	DIF: 6 digit BCD
		FD	VIF: FD
		3A	VIFE: dimensionless / no VIF
		56 34 12	12345.6 W (12.3456 kW)
6	L2 reactive power	0B	DIF: 6 digit BCD
		FD	VIF: FD
		3A	VIFE: dimensionless / no VIF
		56 34 12	12345.6 W (12.3456 kW)
6	L3 reactive power	0B	DIF: 6 digit BCD
		FD	VIF: FD
		3A	VIFE: dimensionless / no VIF
		56 34 12	12345.6 W (12.3456 kW)

Bytes	Parameters	Data structure	Notice
5	L1 active power	0B	DIF: 6 digit BCD
		2A	VIF: 0.1 W (xx.xxxx kW)
		56 34 12	12345.6 W (12,3456 kW)
5	L2 active power	0B	DIF: 6 digit BCD
		2A	VIF: 0.1 W (xx.xxxx kW)
		56 34 12	12345.6 W (12,3456 kW)
5	L3 active power	0B	DIF: 6 digit BCD
		2A	VIF: 0.1 W (xx.xxxx kW)
		56 34 12	12345.6 W (12,3456 kW)
6	Total reactive power	0B	DIF: 6 digit BCD
		FD	VIF: FD
		3A	VIFE: dimensionless / no VIF
		56 34 12	12345.6 W (12.3456 kW)
6	L1 reactive power	0B	DIF: 6 digit BCD
		FD	VIF: FD
		3A	VIFE: dimensionless / no VIF
		56 34 12	12345.6 W (12.3456 kW)
6	L2 reactive power	0B	DIF: 6 digit BCD
		FD	VIF: FD
		3A	VIFE: dimensionless / no VIF
		56 34 12	12345.6 W (12.3456 kW)
6	L3 reactive power	0B	DIF: 6 digit BCD
		FD	VIF: FD
		3A	VIFE: dimensionless / no VIF
		56 34 12	12345.6 W (12.3456 kW)

Bytes	Parameters	Data structure	Notice
5	Total power factor	0A	DIF: 4 digit BCD
		FD	VIF: FD
		3A	VIFE: dimensionless / no VIF
		00 05	0.500
5	A power factor	0A	DIF: 4 digit BCD
		FD	VIF: FD
		3A	VIFE: dimensionless / no VIF
		00 05	0.500
5	B power factor	0A	DIF: 4 digit BCD
		FD	VIF: FD
		3A	VIFE: dimensionless / no VIF
		00 05	0.500
5	C power factor	0A	DIF: 4 digit BCD
		FD	VIF: FD
		3A	VIFE: dimensionless / no VIF
		00 05	0.500
5	Frequency	0A	DIF: 4 digit BCD
		FD	VIF: FD
		3A	VIFE: dimensionless / no VIF
		00 50	50.00 Hz
1	End	CS	
1		16	

9.7. How to read password

Start	L field	L field	Start	C field	A field	CI field	Check sum	Stop
68	3	3	68	11	addr	03	CS	16

Master to Slave: 68 03 03 68 11 address 03 CS 16

Slave to Master: 68 05 05 68 11 address 03 passwordH passwordL CS 16 68

9.7.1. Change to a new password

Master to Slave: 05 05 68 11 address 04 passwordH passwordL CS 16

Slave to Master: E5

9.8. How to reset all resettable energy data

Start	L field	L field	Start	C field	A field	CI field	Check sum	Stop
68	3	3	68	11	addr	0d	CS	16

Example: addr : 01

Master to Slave: 68 03 03 68 11 01 0D 1F 16

Slave to Master: E5

9.9. Set demand interval, slide time, display time, LED time

Wyślij: 68 09 09 68 53 FE 51 30 01 60 01 05 06 3F 16

Start	L field	L field	Start	C field	A field	CI field	DIF	VIF	Check sum	Stop
68H	09	09	68H	53/73	FE	51	30	01	CS	16

Example: (Meter address is 01)

Master to Slave: 68 09 09 68 53 FE 51 30 01 60 01 05 06 3F 16

Slave to Master: E5

Demand interval, slide time, display time, LED time

Display time=0: the display does not scroll automatically.

LED time=0: Backlight always active min-min-s-min 4 Bytes

9.10. Read demand interval, slide time, display time, LED time

Start	L field	L field	Start	C field	A field	CI field	DIF	VIF	Check sum	Stop
68H	05	05	68H	53/73	FE	51	30	81	CS	16

Example: (Meter address is 01)
 Master to Slave: 68 05 05 68 53 FE 51 30 81 53 16
 Slave to Master: E5

Bytes	Parameters	Data structure	Notice
4	Header telegram	68 16 16 68	Header telegram RSP_UD
3		08 A 72	C field =08 address A CI field72
4		78 65 34 21	Identification number =12345678
2		24 40	Manufacturer ID 4024
1		01	Generation 1
1		02	Energy meter
1		55	ACCESS NO
1		00	STATUS
2		00 00	Signature
7		Demand interval, slide time, display time, LED time	0A
	FD		VIF: FD
	3A		VIFE: dimensionless / no VIF
	15010610		Demand interval: 15 min. Slide time: 01 min. Display time: 06 sec LED time: 10 sec
1	Check sum	CS	
1	End	16	

9.11. Read the measurement mode

Start	L field	L field	Start	C field	A field	CI field	Data	Check sum	Stop
68	03	03	68	11	addr	0A	01/02/03	CS	16

Example: (Meter address is 01)
 Master to Slave: 68 03 03 68 11 01 09 1B 16
 Slave to Master: 68 04 04 68 11 01 09 01 1C 16
 The red-lighted **01** represents the measurement mode:
 01: means active energy
 02: means active energy + reactive energy
 03: means active energy - reactive energy

9.12. Set up the measurement mode

Start	L field	L field	Start	C field	A field	CI field	Data	Check sum	Stop
68	04	04	68	11	addr	0A	01/02/03	CS	16

Example: (Meter address is 01)
 Master to Slave: 68 04 04 68 11 01 0A 01 1C 16
 Slave to Master: E5
 The red-lighted **01** represents the measurement mode:
 01: means active energy
 02: means active energy + reactive energy
 03: means active energy - reactive energy

9.13. Read the output mode of pulse 1

Start	L field	L field	Start	C field	A field	CI field	Check sum	Stop
68	03	03	68	11	addr	10	CS	16

Example: (Meter address is 01)
 Master to Slave: 68 03 03 68 11 01 10 22 16 68
 Slave to Master: 04 04 68 11 01 10 01 23 16
 The red-lighted **01** represents the output mode of pulse 1:
 01: Import active energy
 02: Import + export active energy
 04: Export active energy (default)
 05: Import reactive energy
 06: Import + export reactive energy
 08: Export reactive energy

9.14. Set up the output mode of pulse 1

Start	L field	L field	Start	C field	A field	Cl field	Data	Check sum	Stop
68	08	08	68	11	addr	11	01/02/04/05/06/08	CS	16

Example: (Meter address is 01)

Master to Slave: 68 04 04 68 11 01 11 01 24 16

Slave to Master: E5

The red-lighted **01** represents the output mode of Pulse1:

01: Import active energy

02: Import + export active energy

04: Export active energy (default)

05: Import reactive energy

06: Import + export reactive energy

08: Export reactive energy

9.15. Read the constant of pulse 1

Start	L field	L field	Start	C field	A field	L field	Check sum	Stop
68	03	03	68	11	addr	12	CS	16

Example: (Meter address is 01)

Master to Slave: 68 03 03 68 11 01 12 24 16

Slave to Master: 68 04 04 68 11 01 10 00 22 16

The red-lighted **00** represents the constant of pulse 1:

00: 0.0025 kWh (kvarh)/pulse (default)

01: 0.01 kWh (kvarh)/pulse

02: 0.1 kWh (kvarh)/pulse

03: 1 kWh (kvarh)/pulse

04: 10 kWh (kvarh)/pulse

05: 100 kWh (kvarh)/pulse

9.16. Set up the constant of pulse 1

Start	L field	L field	Start	C field	A field	Cl field	Data	Check sum	Stop
68	08	08	68	11	addr	11	00/01/02/03/04/05	CS	16

Example: (Meter address is 01)

Master to Slave: 68 04 04 68 11 01 13 00 25 16

Slave to Master: e5

The red-lighted **00** represents the constant of pulse 1:

00: 0.0025 kWh (kvarh)/pulse (default)

01: 0.01 kWh (kvarh)/pulse

02: 0.1 kWh (kvarh)/pulse

03: 1 kwh (kvarh)/pulse
04: 10 kwh (kvarh)/pulse
05: 100 kwh (kvarh)/pulse

10. Manufacturer's warranty

1. The product is covered by 24 month warranty from the date of purchase.
2. The warranty is valid only with a proof of purchase.
3. The notification of the complaint must be made at the place of purchase or directly at the manufacturer:
(phone: +48 (42) 227 09 71; e-mail: reklamacje@fif.com.pl)
4. During the warranty period in the case of a justified complaint the manufacturer commits in accordance with the provisions of the consumer rights to repair the product, replace it with a new one or refund.
5. The complaint will be processed within 14 days from the date of delivering the product to the service point.
6. Warranty does not cover:
 - a. mechanical and chemical damages;
 - b. damages resulting from improper use or from the use inconsistent with the user manual;
 - c. damages incurred after the sale as a result of accidents or other events for which nor the producer, nor the place of sale are responsible, for example damages in transit, etc.
7. Warranty does not cover actions that user should perform in accordance with the user manual, for example installing multi-meter, building electrical installation, installing other required electrical protection, checking, etc.

Warning!

Do not make any changes in the device by yourself. This may cause damage or improper operation of the device, which can lead to damage to the controlled device and may pose a danger to the operators. In such cases, the manufacturer is not liable for consequential events and may refuse the guarantee in case of complaint.